

External view

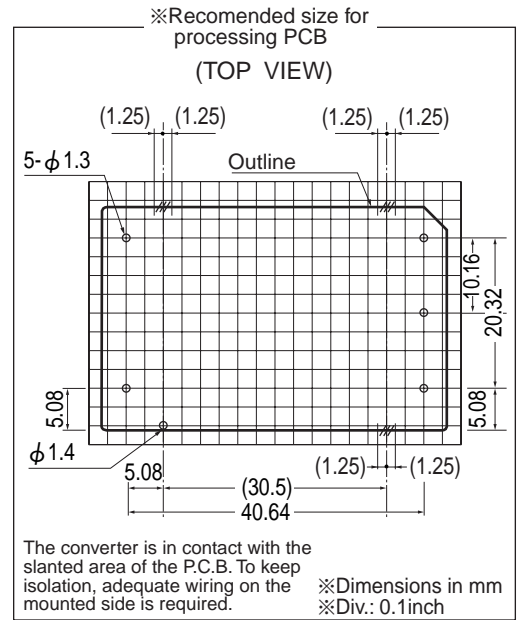

Performance data

■ STATIC CHARACTERISTICS (ZW30512)

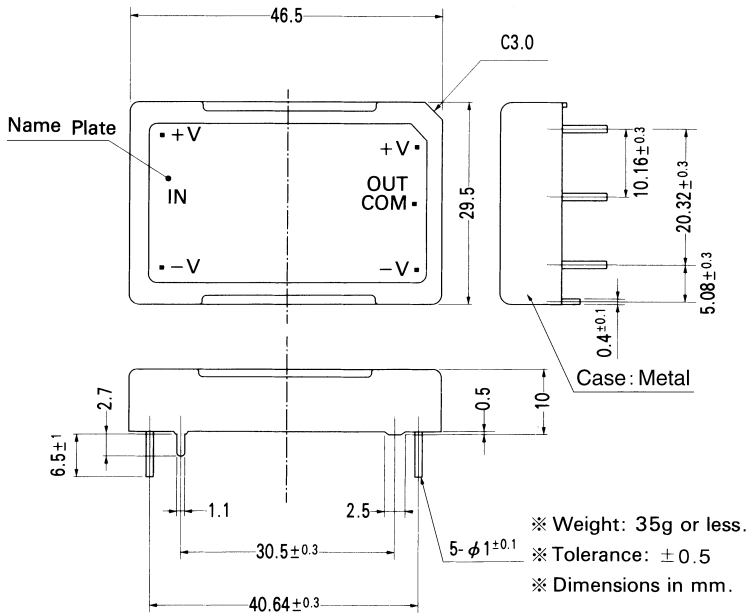
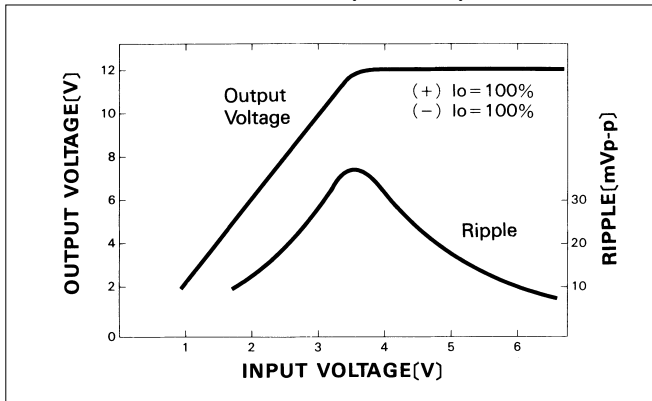

■ RISE TIME & FALL TIME (ZW30512)

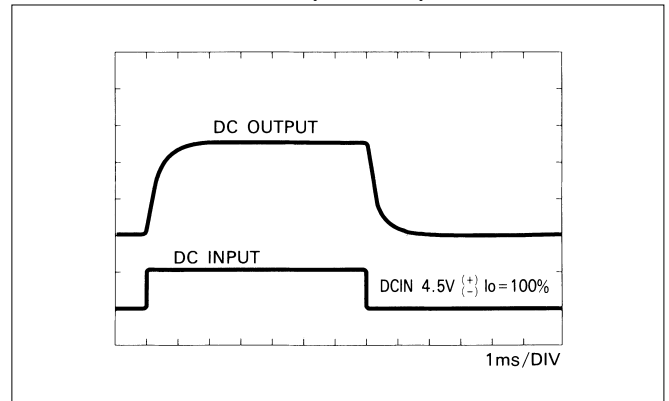

■ OVERCURRENT CHARACTERISTICS (ZW30512)

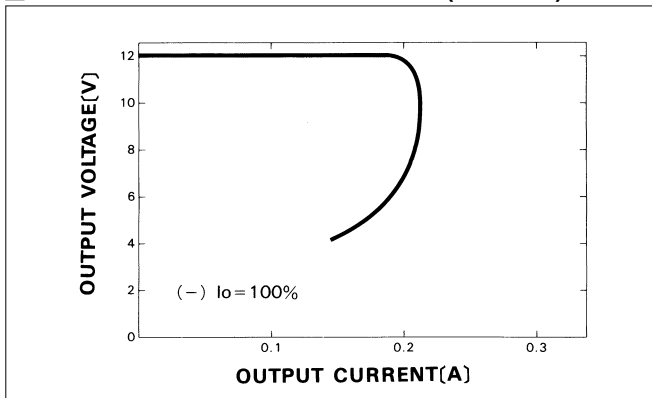

■ DERATING CURVE

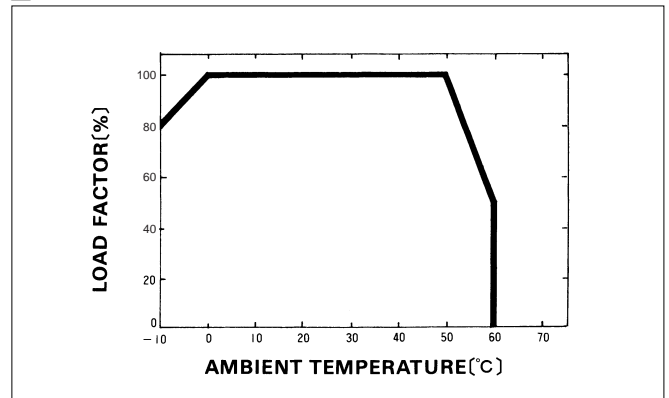

Z