

External view

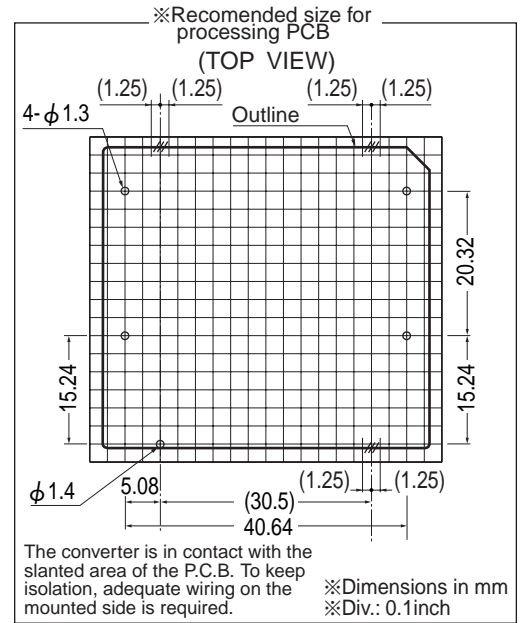

Performance data

■ STATIC CHARACTERISTICS (ZS62405)

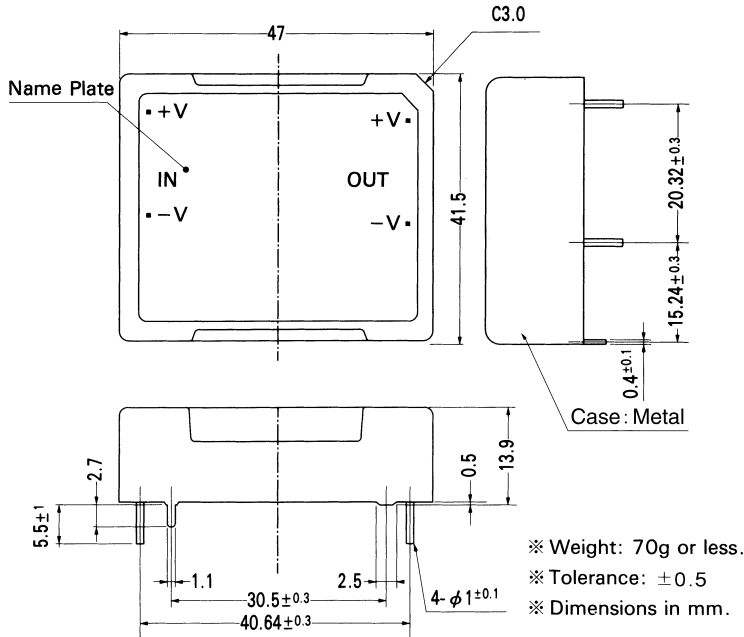
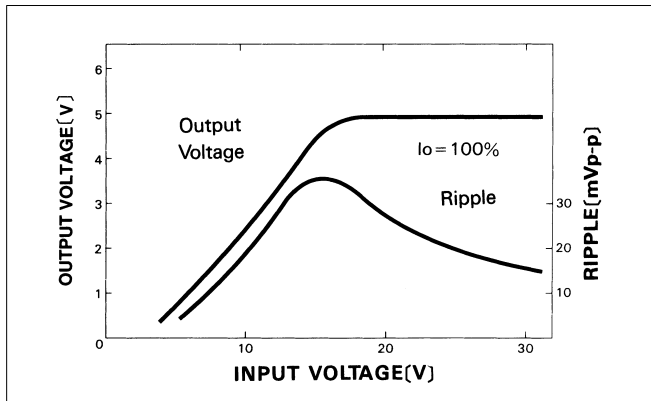

■ RISE TIME & FALL TIME (ZS62405)

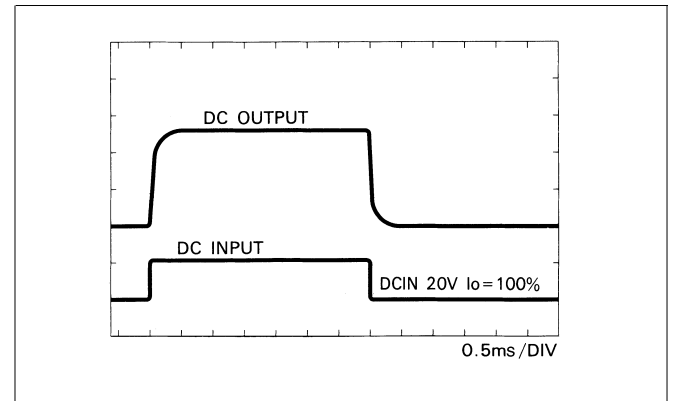

■ OVERCURRENT CHARACTERISTICS (ZS62405)

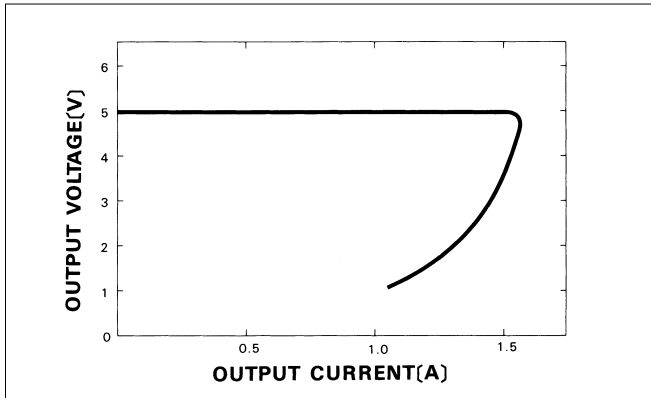

■ DERATING CURVE

