

External view

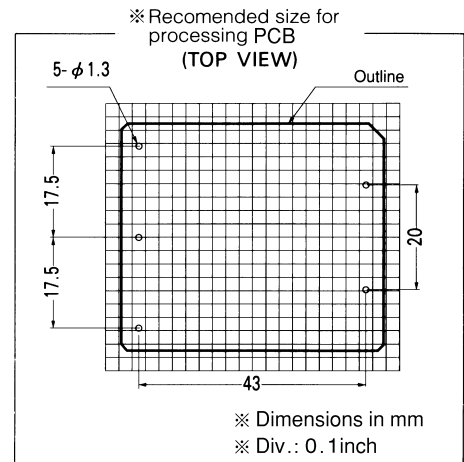
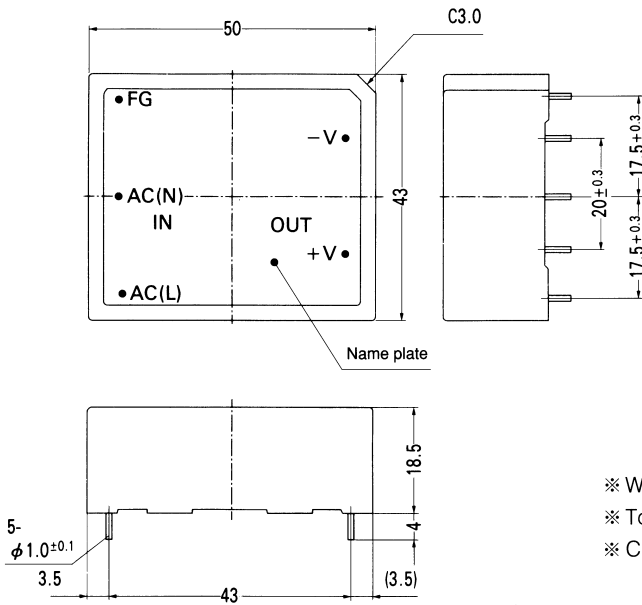

- ※ Weight: 65g or less
- ※ Tolerance: ±0.5
- ※ Case: PBT

Performance data

■ STATIC CHARACTERISTICS (YS512A)

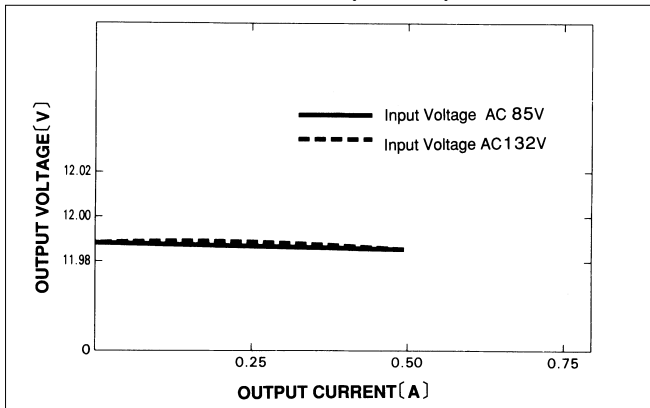

■ RISE TIME & FALL TIME (YS512A)

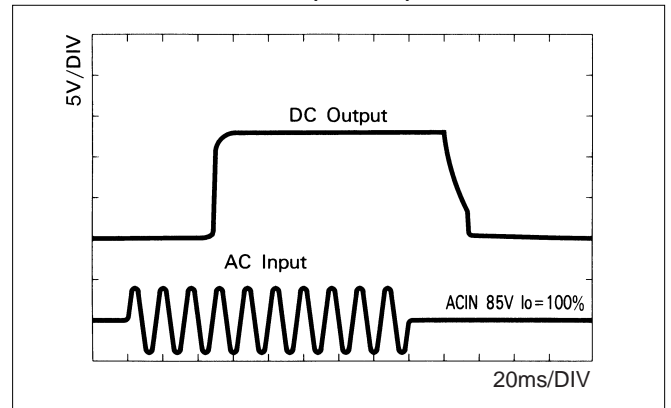

■ OVERCURRENT CHARACTERISTICS (YS512A)

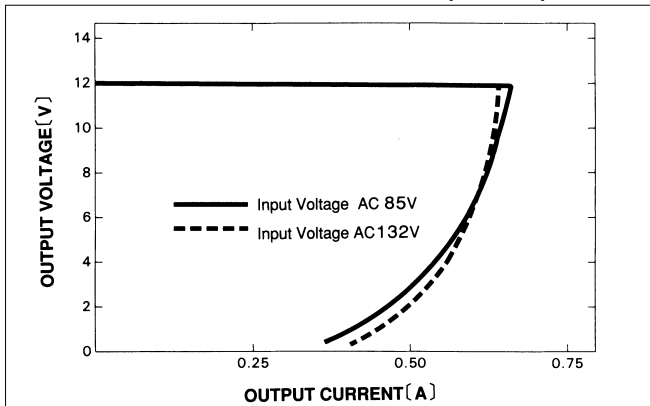

■ DERATING CURVE

