

Block diagram

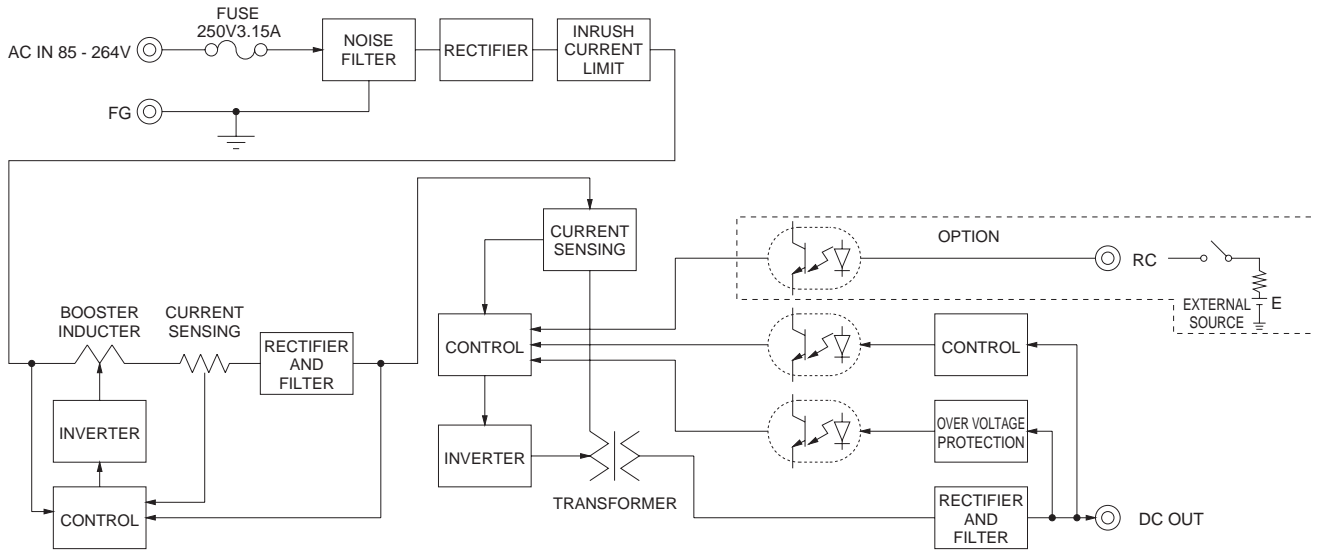

External view

※ External size of option T,J,R,N,N1 and V is different from standard model and refer to 7 Option of instruction manual for details.

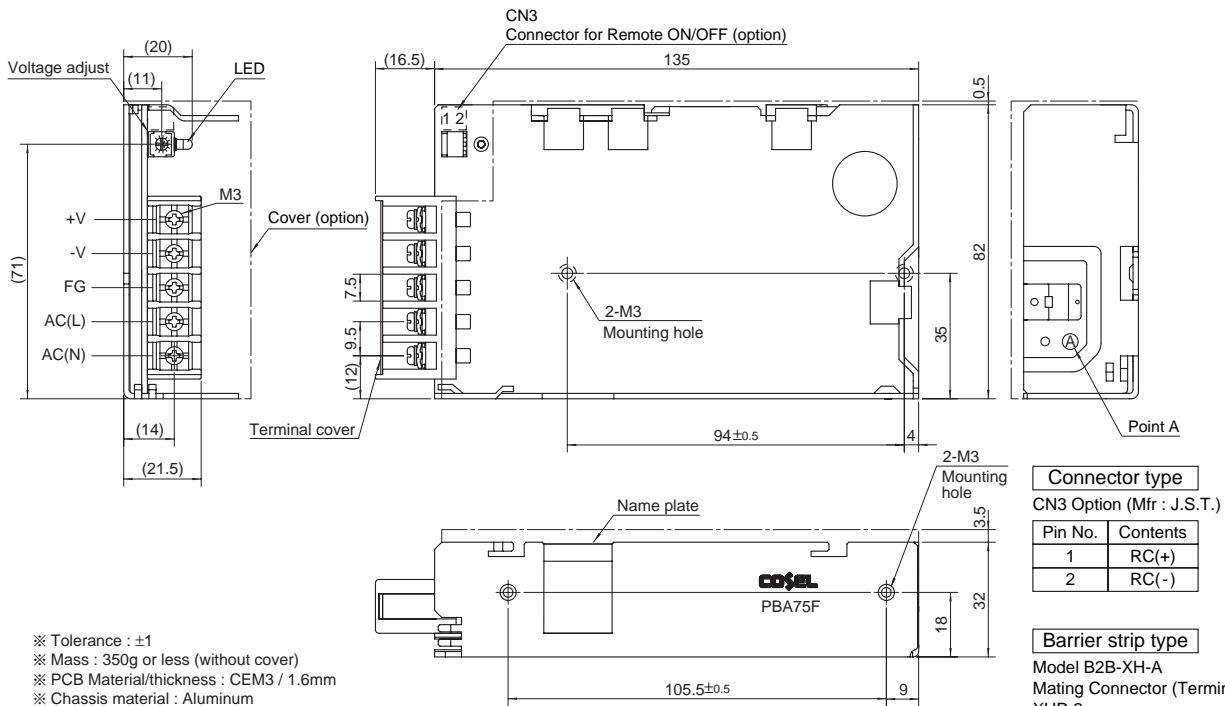

- ※ Tolerance : ±1
- ※ Mass : 350g or less (without cover)
- ※ PCB Material/thickness : CEM3 / 1.6mm
- ※ Chassis material : Aluminum
- ※ Dimensions in mm
- ※ Mounting torque : 0.49N • m(5kgf • cm)max
- ※ Screw tightening torque : M3 0.8N • m(8.5kgf • cm)max
- ※ Please connect earth to the unit in 2-M3 holes.

Connector type
CN3 Option (Mfr : J.S.T.)

Pin No.	Contents
1	RC(+)
2	RC(-)

Barrier strip type
Model B2B-XH-A
Mating Connector (Terminal)
XHP-2
(BXH-001T-P0.6
or SXH-001T-P0.6)